

PROPRIETARY AND CONFIDENTIAL

THE INFORMATION CONTAINED IN THIS DRAWING IS THE SOLE PROPERTY OF UNICE E-O SERVICES INC. ANY REPRODUCTION IN PART OR AS A WHOLE WITHOUT THE WRITTEN PERMISSION OF UNICE E-O SERVICES INC IS PROHIBITED.

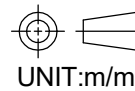
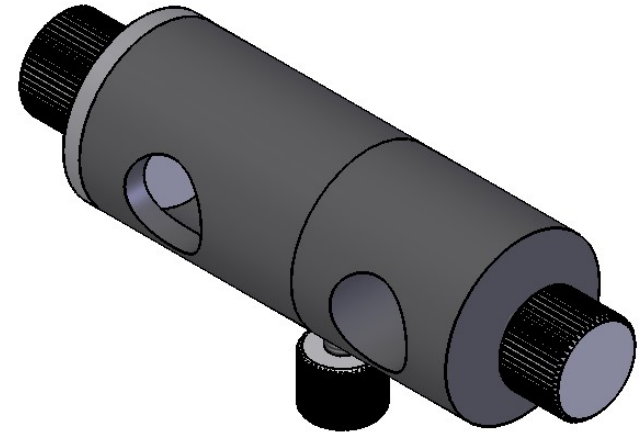
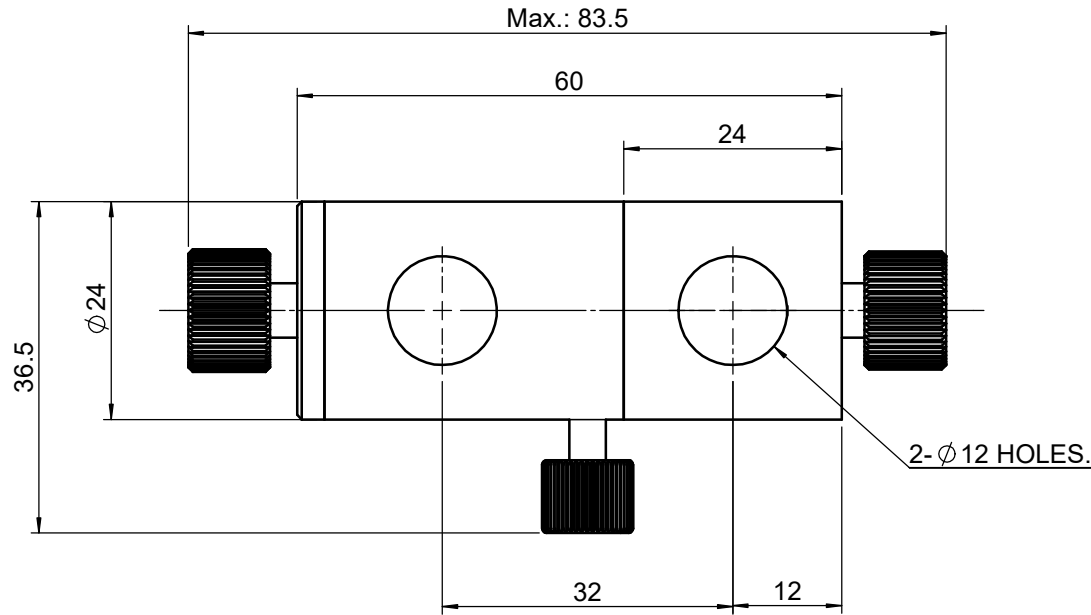

 Unice E-O Services Inc. No.5, Andong Rd., Chung Li District, Taoyuan City 32063, Taiwan, R.O.C.			TITLE:	
			02CAP-3(M)-A	
			DWG. NO.	02CAP-3(M)-A
			MATERIAL:	N/A
DRAWN	Miki	2010/12/30	SCALE:	1.2:1
ENG APPR.	Johnny	2010/12/30	REV	0